

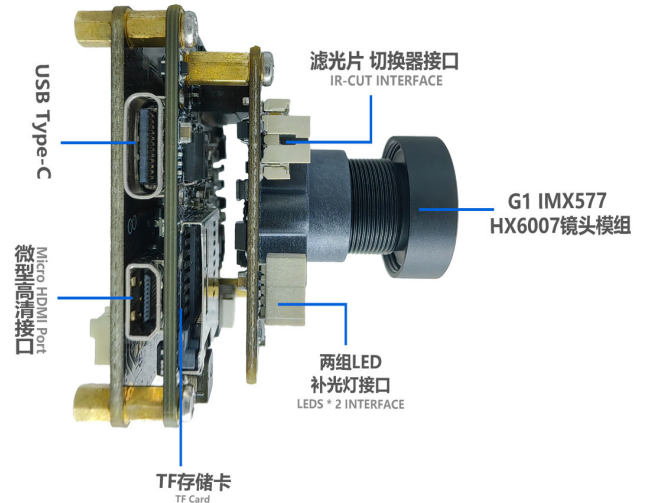

KLT-G1M9NK3+KLT-CMFL6007-IMX577 V1.0

Ai Master Board + Network Board + 12.3MP Sony IMX577 Fixed Focus Camera Module Development Kit

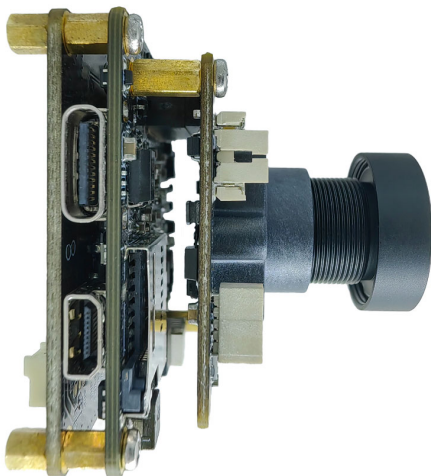

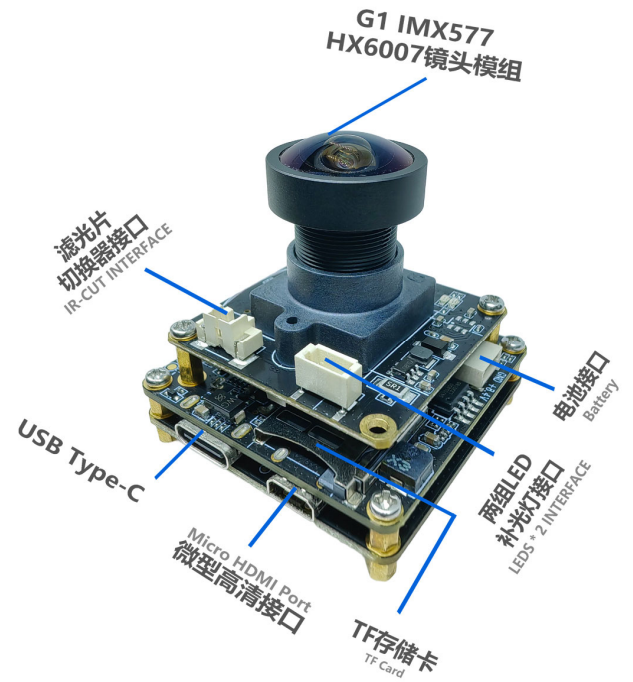

KLT-G1M9NK3+KLT-CMFL6007-IMX577 V1.0

Ai Master Board + Network Board + 12.3MP Sony IMX577 Fixed Focus Camera Module Development Kit

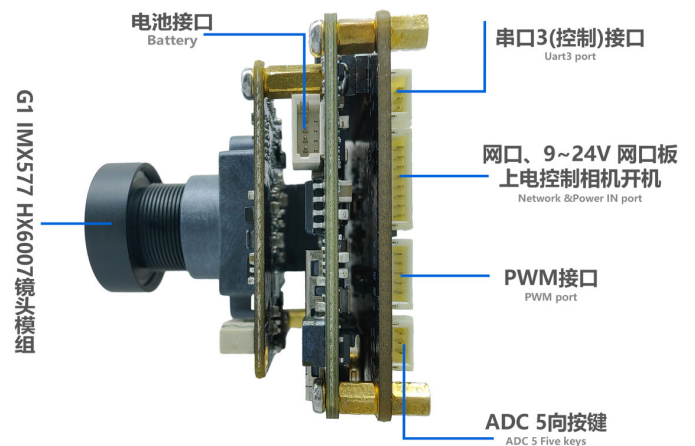
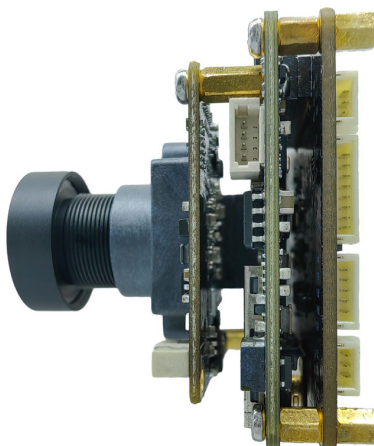
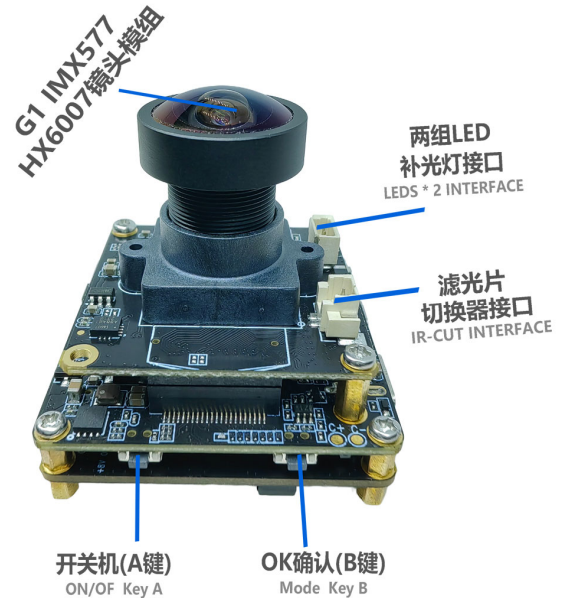

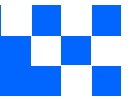

KLT-G1M9NK3+KLT-CMFL6007-IMX577 V1.0

Ai Master Board + Network Board + 12.3MP Sony IMX577 Fixed Focus Camera Module Development Kit

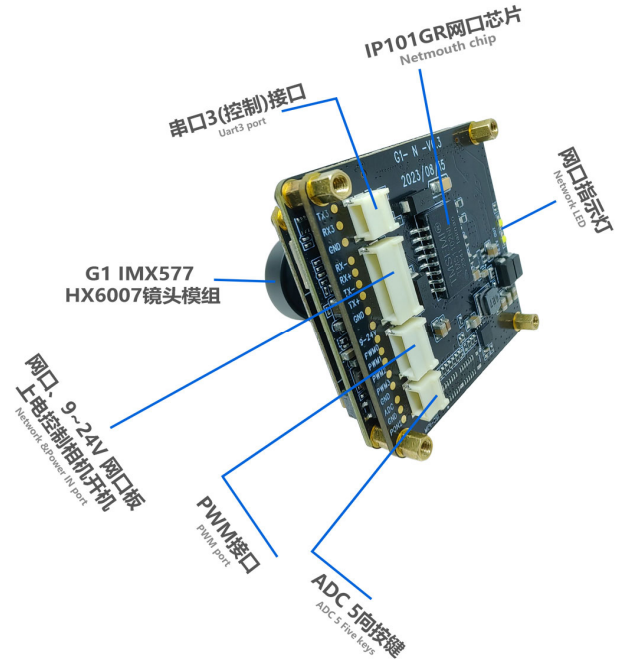
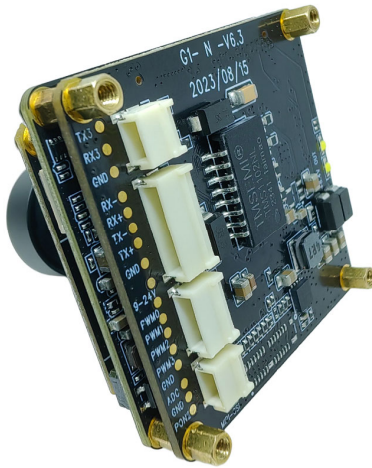

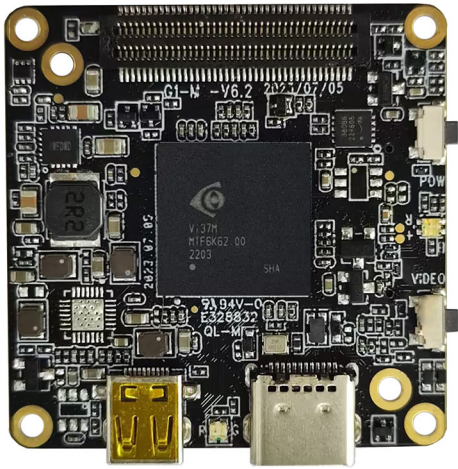
**KLT-G1M9 V6.2****iCatch V39 Ai-Powered Image Processing SoC Master Board**

Front View

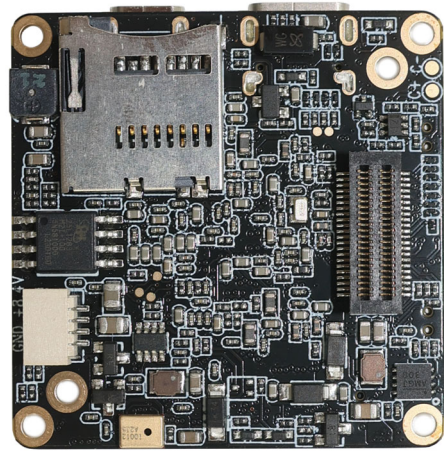

Back View

Overview

Equipped with iCatch V39, built-in 2GB DDR3, supports up to 4K@60FPS (differential), 4K@30FPS, 1080P@120FPS H.264 encoded video. Onboard support Type-C, HDMI, TF memory card, recording, 2 control buttons, buzzer, battery power supply, etc.

This master board extension also supports WiFi, LCD display, CVBS, lens module, UART, I2C, SPI, PWM, MIC and other expansion interfaces. The board size is 38x38mm. Widely used in drones, mini DV, wearable devices, sports cameras, face recognition, USB cameras and other camera products.



KLT-G1M9 V6.2

iCatch V39 Ai-Powered Image Processing SoC Master Board

Hardware Specifications

Model No.	KLT-G1M9 V6.2
Main Control Chipset (DSP)	iCatch V39
Image Sensor Interface	MIPI
Battery Voltage	7.4V - 7.7V High Voltage Lithium Battery
Storage Type	External TF Card, Supports 8GB - 512GB Class 10 and Above, U3 is Recommended
Type-C Port	Type-C USB 5V Connection to Computer USB Mode Connection to PCCAM (Camera) Mode
LED Indicator Type	Three Color Light (Red, Green, Blue)
2 Control Button Type	Power Button (A), OK Button (B)
Power Supply	Supports 3 Power Supply Methods At The Same Time (1) 5V USB to Type-C Port Power Supply (2) 9V-24V WiFi Board or Network Port board Power Supply (3) 6.8V-8.4V Battery Power Supply (The 3-Axis Gimbal Version Does Not Support 5V USB)
Operating Temperature	-10°C to +60°C Without Housing
Storage Temperature	-20°C to +80°C
Humidity	20% to 80%
PCB Dimensions	38 x 38 mm
PCB Screw Hole Spacing	External (34mm x4), Internal (28mm x2)
PCB Screw Hole Diameter	2 mm
Optional Camera Configuration	(1) KLT-G1M9 V6.2 + Camera (2) KLT-G1M9 V6.2 + Camera + KLT-G1WF V6.3 WiFi Board (3) KLT-G1M9 V6.2 + Camera + KLT-G1NK V6.3 Ethernet Board
Supportive Image Sensors	13MP: IMX258 12MP: IMX377 OS21D40 IMX577 IMX386 IMX378 8MP: IM317 5MP: IMX335 2MP: IMX290 IMX385
Optional Extension Ports	WiFi, Ethernet Network Port, Display, Audio IC, Lens Module, UART, I2C, SPI, PWM, MIC, etc.



KLT-G1M9 V6.2

iCatch V39 Ai-Powered Image Processing SoC Master Board

Photo Image Settings

Resolution	20MP, 13MP, 12MP, 10MP, 8MP, 5MP, 3MP, 2MP
Time Lapse Photography	OFF, 3S, 5S, 7S
Continuous shooting	OFF, 3-Shot, 7-Shot, 15-Shot, 30-Shot
White Balance	Auto, Sunny, Cloudy, Fluorescent, Incandescent
Power Frequency	50Hz, 60Hz
Exposure Compensation	EV 0.0, EV 3.0, EV 7.0, EV 10.0, EV 13.0, EV 17.0, EV 20.0, EV -3.0, EV -7.0, EV -10.0, EV -13.0, EV -17.0, EV -20.0
Time Lapse Photo Interval	OFF, 1S, 2S, 3S, 4S, 5S, 6S, 7S, 8S, 10S, 13S, 15S, 20S, 25S, 30S, 40S, 1min
Time Lapse Duration	No Limit, 1min, 3min, 5min, 10min, 20min, 30min, 1hr, 2hr, 3hr, 5hr
Photo Time Watermark	OFF, Date, Date and Time

Wifi、显示屏、网口、uart、PWM等扩展接口

For Wifi, Display, Network, uart, PWM Etc.

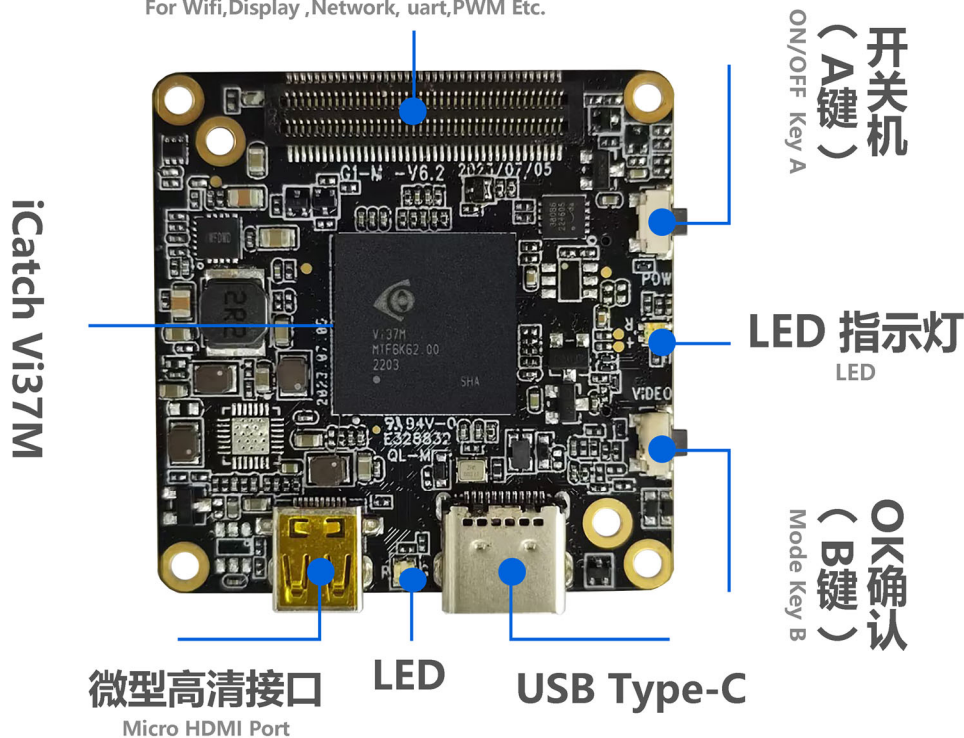



KLT-G1M9 V6.2

iCatch V39 Ai-Powered Image Processing SoC Master Board

Video Settings

Resolution	16:9 (4K, 2.7K, 1080P, 720P) 4:3 (1440P) Currently Only IMX377 Sensor Supports 1440P
Frame Rate	24FPS, 25FPS, 30FPS, 48FPS, 50FPS, 60FPS, 120FPS, 240FPS
Slow Motion Recording	OFF, 4K2X, 1080P4X, 720P8X
Fast Motion Recording	OFF, 2X, 5X, 10X, 15X, 30X
Automatic Recording	OFF, ON
Time Lapse Video Mode	OFF, 1S, 2S, 3S, 4S, 5S, 6S, 7S, 8S, 10S, 13S, 15S, 20S, 25S, 30S, 40S, 60S
Time Lapse Duration	No Limit, 1min, 3min, 5min, 10min, 20min, 30min, 1hr, 2hr, 3hr, 5hr
Pre-recording	OFF, ON (for Option ON, 5 Seconds of Video is Pre-recorded)
EIS Anti-Shake	OFF, ON
Image Quality Enhancement	Super Good, Very Good, Normal (Referral to Actual Video Effect Quality, Not for Preview)
Image Rotation	Normal, Vertical, Horizontal (for Recorded Video)
Recording Time	No Limit, 1min, 5min
Automatic Screen Off	OFF, 60S, 180S, 300S
Light Metering Mode	Center, Multi-point, Single Point
Video Recording File Time	No Limit, 1min, 5min
Loop Recording	OFF, ON
Recording Volume	0, 1, 2, 3
Video Time Watermark	OFF, Date, Date and Time



KLT-G1M9 V6.2

iCatch V39 Ai-Powered Image Processing SoC Master Board

System Settings

Automatic Shut Down	OFF, 1min, 3min, 5min, 10min, 15min
USB Auto Power On	Turn ON, Turn OFF
Languages	English, Simplified Chinese, Traditional Chinese (Select Language Through Configuration File in the Card)
Button Touch Tone	Turn ON, Turn OFF
Automatically Turn On WiFi	Turn ON, Turn OFF
WiFi Frequency Bands	2.4GHz or 5GHz (Dual Band Single Channel)
Display Brightness	Low, Medium, High Brightness (for Touch Screen)
Display Setting	Conventional Display, Full Screen Display (for Touch Screen)
Fill Light A (White Light)	Auto, OFF, ON (for Use with Fill Light Board)
Fill Light B (Infrared Light)	Auto, OFF, ON (for Use with Fill Light Board)
IR Cut Settings	Auto, OFF, ON (for Use with IR Cut Function Modules)
Special Effects	Original Image, Black and White, Natural, Negative, Warm Tones, Contrast (for Touch Screen)
White Balance	Auto, Sunny, Cloudy, Fluorescent, Incandescent
Date and Time	Year, Month, Day, Hour, Minute
Format	No, Yes
Reset	No, Yes
Card Information	Displays Video Card Capacity and Free Space
Device Information	Displays Firmware Version

Gimbal Functions and Settings

Gimbal Functions	Centering, Calibration
Sensitivity	Follow Softly, Follow Sensitively
Follow Mode	Full Follow, Heading Follow, Heading and Pitch Follow
Pitch Axis Control	Turn ON, Turn OFF



KLT-G1M9 V6.2

iCatch V39 Ai-Powered Image Processing SoC Master Board

Camera Features

Continuous Shooting	Long Press the OK Button (B) to Shoot Continuously, Release Button to Stop Shooting Continuously
Snapshot	During Recording, Long Press the OK Button (B) to Capture the Video. Release Button to Stop Snapshot
HDMI Output Resolution	4K@30FPS 1080P@60FPS/30FPS 720P@60FPS
Video Start and Stop Function	Short Press the Power Button (A) to Pause or Continue Video Recording
USB Camera Resolution	H.264: 4K@30FPS, 1080P@120FPS, 720P@60FPS (Dependency on Sensor Type and UVC Protocol) MJPG: 5760x3240@10FPS, 4000x3000@10FPS 4K@30FPS, 1080P@30FPS, 720P@30FPS YUY2: 480P@30FPS (Supports Modification of UVC Output on Configurations)
USB Flash Drive	USB Mode when Connected to Computer
Inverted Mode	By Placing a Configuration File in the Card, You Can Modify the Displayed or Captured file and Flip it 180 degrees
WiFi Mode	AP Mode, STA Mode Set WiFi Mode by Putting Configuration Files in the Card or Enter the Menu to Set This Item Through the Touch Screen
Configuration IP Address	By Placing a Configuration File in the Card, You Can Modify the IP and Gateway Address of the Camera. Default is Static IP. Optional on Dynamic IP.
RTSP Video Stream Address	By Placing a Configuration File in the Card, You Can Modify the RTSP video stream address. If There is No Configuration File in the Card, the Default Port is 554.

KLT-G1M9 V6.2**iCatch V39 Ai-Powered Image Processing SoC Master Board****USB Type-C Interface:**

This interface supports USB standard 5V power input, which can power the master board and charge the battery (recommended 7.4V-7.7V battery). Connecting to a computer can directly read files in the TF card and use it as a USB flash drive. It can also be used as a PCCAM USB camera.

The USB interface retains one camera control serial port UART3 and one camera debugging serial port UART1 (the serial port function can be used with the G1-USB serial port debugging board).

Connecting to the Computer USB Flash Drive Mode:

Insert the TF card, connect the other end of the USB to the computer, and automatically enter the USB flash drive mode after booting by default.

Connecting to the Computer PCCAM Mode:

Insert the TF card, connect the other end of the USB to the computer, and automatically enter the USB flash drive mode after booting. Short press the OK button (A) to switch to PCCAM camera mode. (Right-click the computer "Computer", click the left button in the pop-up prompt box to enter "Management", "Device Manager", and you can see the name of the camera identified in "Image Device" camera. Open the camera tool "amcap.exe" to see the current device preview screen).

Battery Power Supply:

6.6V (low power shutdown) to 8.8V, 7.4-7.7V high-voltage and high-density batteries are recommended
Special note: the battery power supply can support up to 12V; but this does not include the gimbal version, the stable power supply voltage of the gimbal version is 8V.

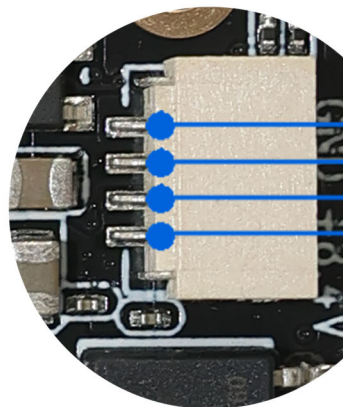
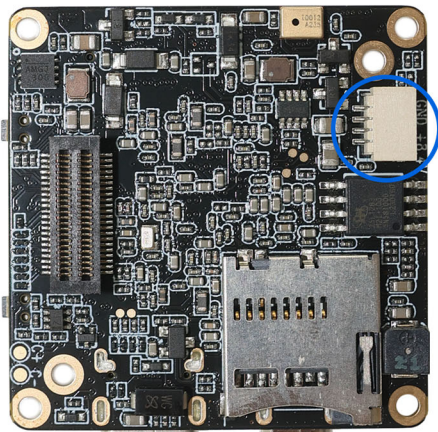

BAT -
BAT +

Battery 7.7V-8.8V
电池供电

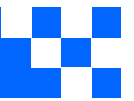
**KLT-G1M9 V6.2****iCatch V39 Ai-Powered Image Processing SoC Master Board****Charge the Battery:**

Use a power adapter (5V2A recommended) to charge the battery of the machine. The red light will be on during charging and the green light will be on when fully charged.

Camera Module:

This interface can be used to expand multiple MIPI sensors, IR-CUT function, LED fill light, serial port UART2, battery power output, micro three-axis gimbal and other functions.

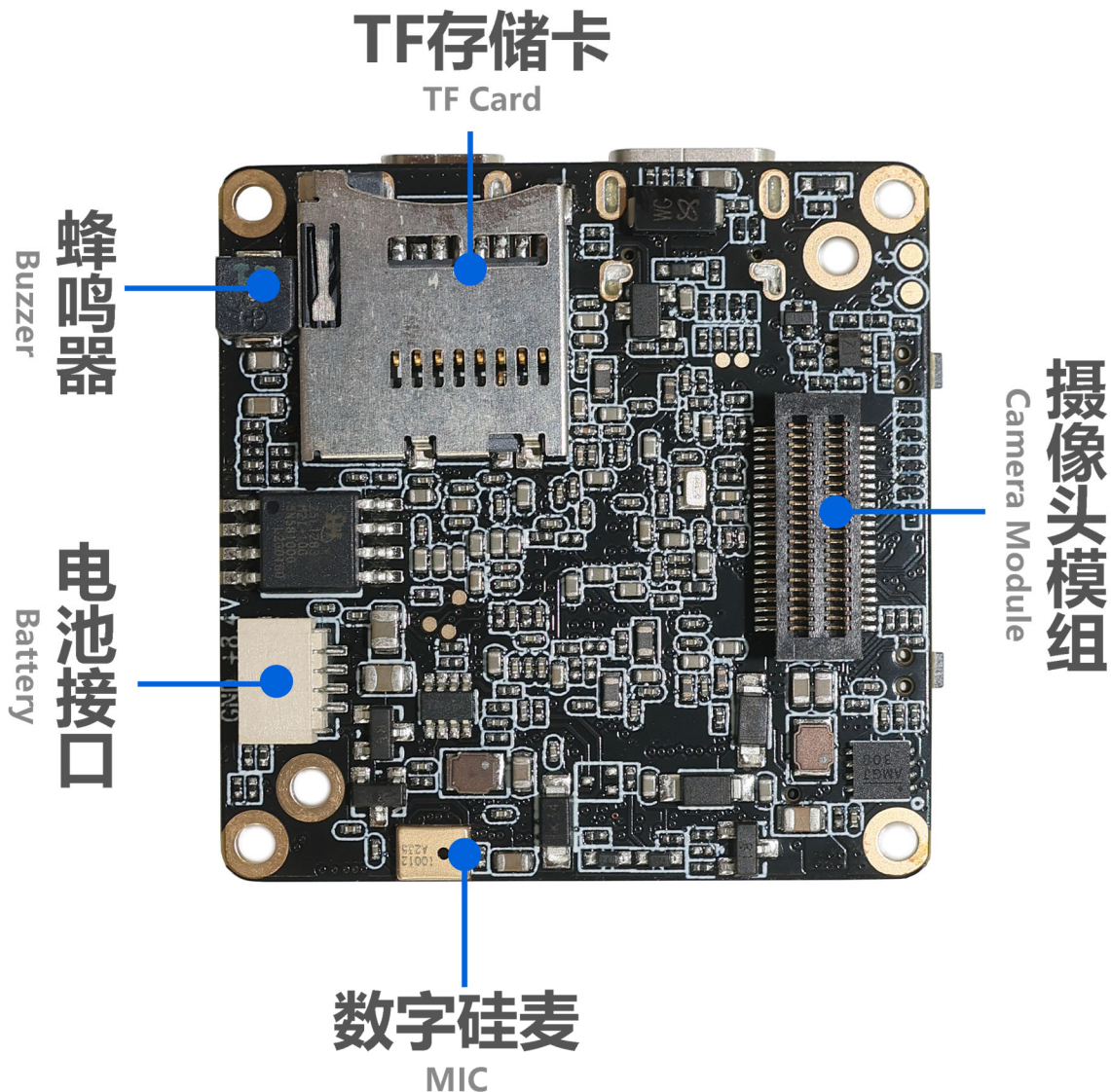



KLT-G1M9 V6.2

iCatch V39 Ai-Powered Image Processing SoC Master Board

Button Instructions:

Button	Mode or Status	Functional Operation
Button A Power Mode	Power ON / OFF	Long Press 1 Second Power ON / OFF
	Standby	Short Press on Switch Mode Video Recording, Snapshot, Playback, Settings
	Setting Mode (with Touch Screen)	Short Press to Scroll Down Menu (After Pressing Button B to Enter Setting)
	Video Recording	Short Press to Pause or Continue Recording
Button B Confirmation OK Video Recording	Standby	In Video Standby Mode, Long Press 3 Seconds to Turn ON / OFF WiFi Mode. Default WiFi is OFF. In Video Recording Mode, Short Press to Start Recording In Snapshot Mode, Short Press to Start Taking Photo Long Press to Start Continue Shooting Release to Stop Continue Shooting
	Video Recording	Short Press to Stop Recording and Save the File Long Press 2 Seconds (Less than 4 Seconds) to Take a Single Frame Shot, Release to Stop Taking Frame Shots Long Press 5 Seconds to Take Continues Frame Shots, Release to Stop Taking Frame Shots
	Setting Mode (with Touch Screen)	Short Press to Confirm and Enter Setting Mode Long Press 2 Seconds to Return Double-Click to Switch Between Settings: Photo / Video / System / 3-Axis Gimbal
	Playback Mode (with Touch Screen)	Short Press to Scroll Up Menu Double-Click to Play / Pause Video or Audio Files Click 3 Times to Mark or Unmark Files. If File is Marked, then the File is Locked and Not Erasable Long Press to Prompt Option to Delete Current File (Long Press to Delete, Short Press to Return) After Entering, Long Press Again to Delete
	Shutdown	Press and Hold to Enter the USB Burning Mode
Reset Function	Standby or Working	Press Button A and B at the Same Time to Shutdown



KLT-G1M9 V6.2

iCatch V39 Ai-Powered Image Processing SoC Master Board

LED Indicator Description:

Functions	Color	Power On	Video Mode	Video Recording	Photo Mode	Photo Snapshot	Playback Mode	Setting Mode
LED Indicator	Red	Always On	Always On	Flashing			Always On	
	Green				Always On	Flash Once	Always On	
	Blue						Always On	Always On

Note: When the device is powered without a TF card inserted, the function indicator light flashes yellow.

Buzzer Sound Description:

Operation Mode	Power On	Power Off	Switching Mode	Start Video Recording	Start Stop Recording	Photo Snapshot	Menu Setting	Menu Scroll Down	Exit Menu Setting
Buzzer Sound	3 Beeps	5 Beeps	1 Beep	1 Beep	2 Beeps	1 Beep	1 Beep	1 Beep	1 Beep

Special Note: When the touch screen is not in use, you can modify the setting parameters through the configuration file. Put the configuration file, such as "CameraConfig_G1A.ini" (the specific configuration file name will vary depending on the lens module) in the root directory of the TF card, and you can modify the corresponding function options in the configuration file. After saving the changes, shut down the machine and restart it to take effect.



KLT-G1NK V6.3 Network Expansion Board

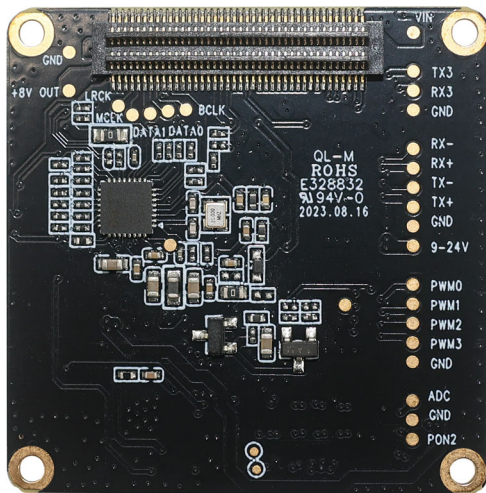

Front View

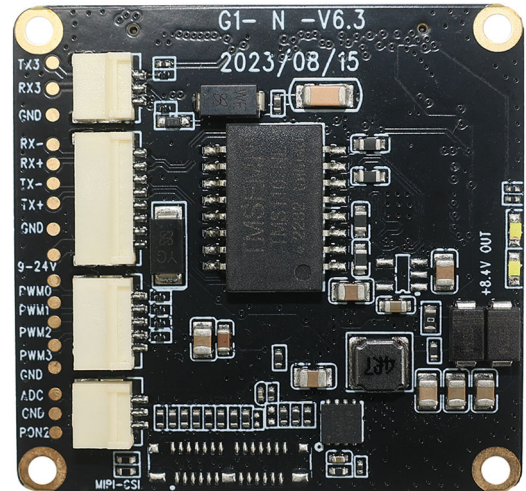

Back View

Overview

This Ethernet network expansion board is equipped with IP101GR fast Ethernet transceiver, supporting extended network port, PWM, serial port, automatic power-on power supply interface, and MIPI interface.

The board PCB size is 38x38mm, and this Ethernet board must be used with our company's designated master board. This board can not work independently.



KLT-G1NK V6.3 Network Expansion Board

Specifications

Model No.	KLT-G1NK V6.3
Ethernet Transceiver	IP101GR
Power Supply	Supports 3 Power Supply Methods At The Same Time (1) 5V USB to Type-C Port Power Supply (2) 9V-24V WiFi Board Power Supply (3) 6.8V-8.4V Battery Power Supply (The 3-Axis Gimbal Version Does Not Support 5V USB)
Transmission Rate	100 Mbps
Serial Port / UART	RX3, TX3, GND
LED Indicator	White Light Indicator at Network Working Status
PWM	PWM0, PWM1/UART3_GND
ADC Button	Up, Down, Left, Right, OK 5-Way ADC Buttons Power Button
Operating Temperature	-10°C to +60°C Without Housing
Storage Temperature	-20°C to +80°C
Humidity	20% to 80%
PCB Dimensions	38 x 38 mm
PCB Screw Hole Spacing	34 mm
PCB Screw Hole Diameter	2 mm
Extendable Functions	PWM0, PWM1/UART3_GND



KLT-G1NK V6.3 Network Expansion Board

Hardware Interface Function Description

IP101GR is an IEEE 802.3/802.3u compliant single-port Fast Ethernet Transceiver for both 100Mbps and 10Mbps operations. It supports Auto MDI/MDIX function to simplify the network installation and reduce the system maintenance cost. To improve the system performance, IP101GR provides a hardware interrupt pin to indicate the link, speed and duplex status change. IP101GR provides Media Independent Interface (MII) or Reduced Media Independent Interface (RMII) to connect with different types of 10/100Mbps Media Access Controller (MAC). IP101GR is designed to use category 5 unshielded twisted-pair cable or Fiber-Optic cables connecting to other LAN devices.

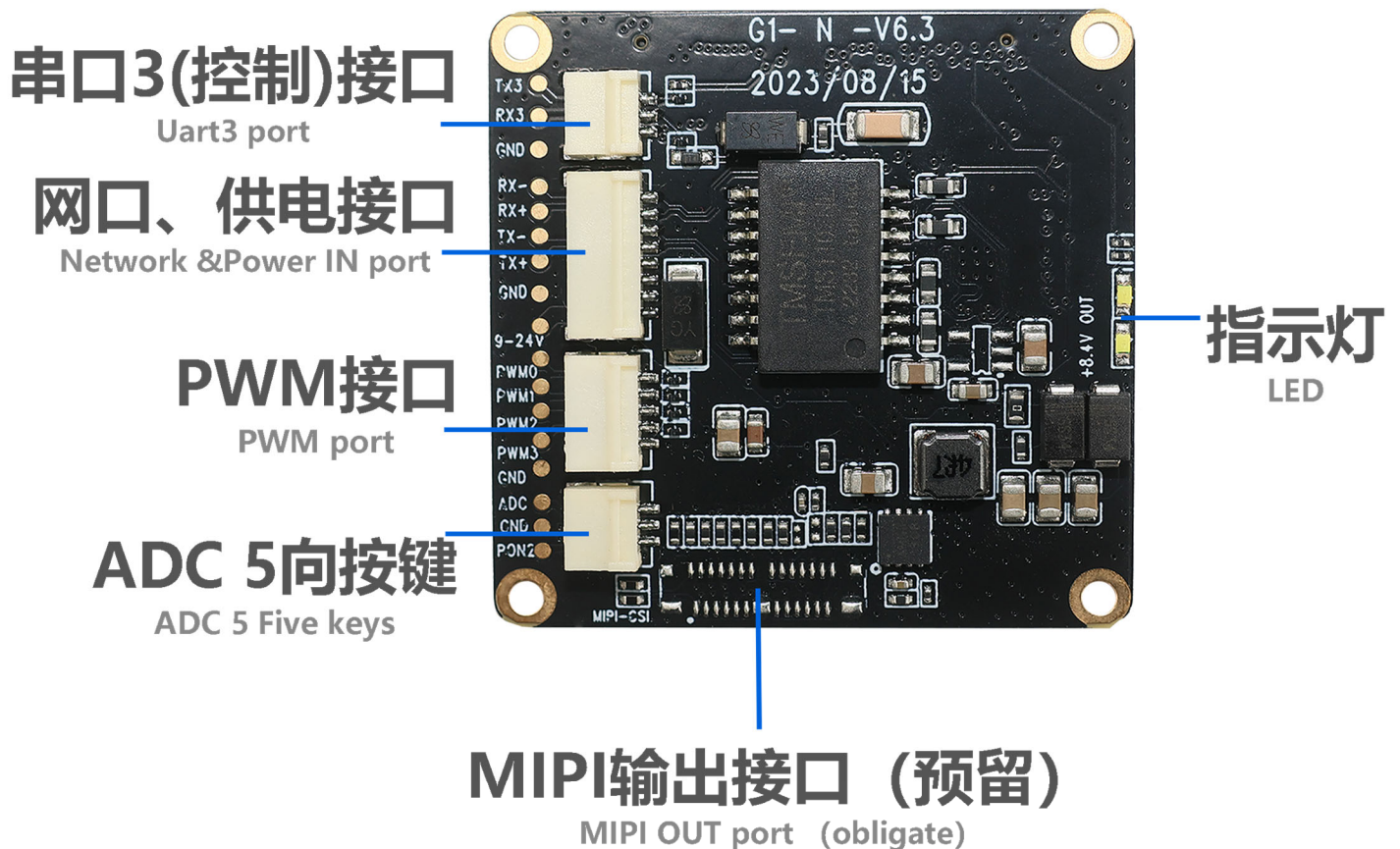



KLT-G1NK V6.3 Network Expansion Board

Commands can be input through this serial port (UART3) to set and control the camera.

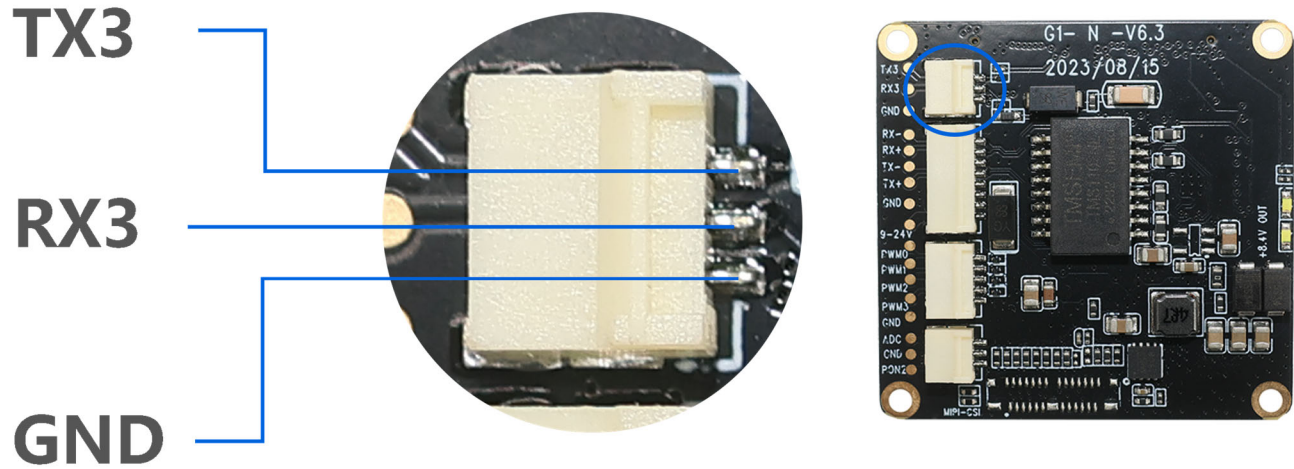

When used with the master board, this power supply interface supports the use of a DC power supply between 9V and 24V, or a lithium battery type 8V to 16.8V to power the camera automatically.

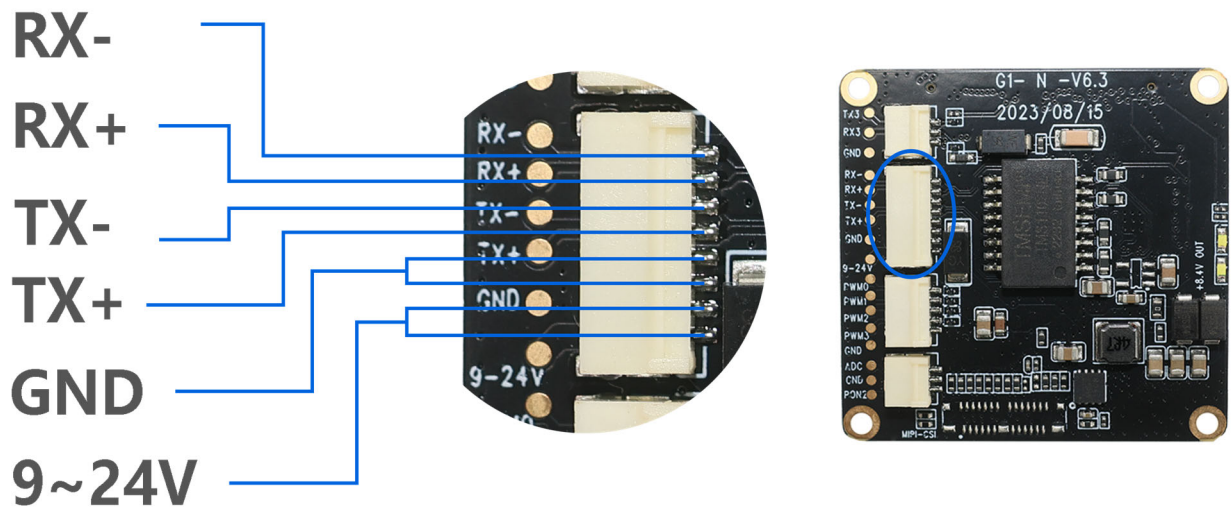



KLT-G1NK V6.3 Network Expansion Board

The PWM function interface, which can be used to control camera mode switching, photo taking, video recording and other functions.

PWM0
PWM1
PWM2
PWM3
GND

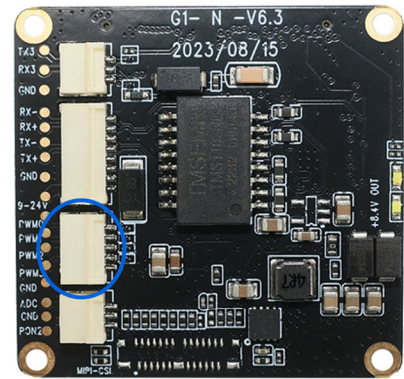
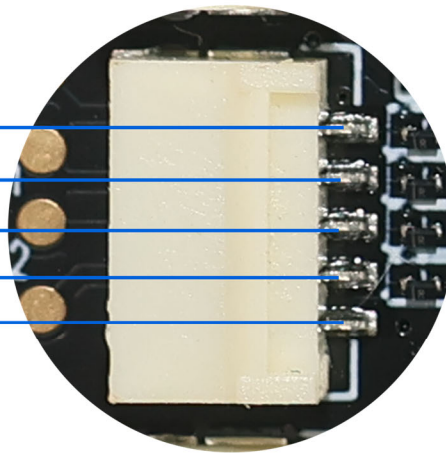

Supports one ADC button interface, which can be connected to five buttons: up, down, left, right, and OK confirm. It supports external buttons to control the camera power on and off.

ADC
GND
PON2

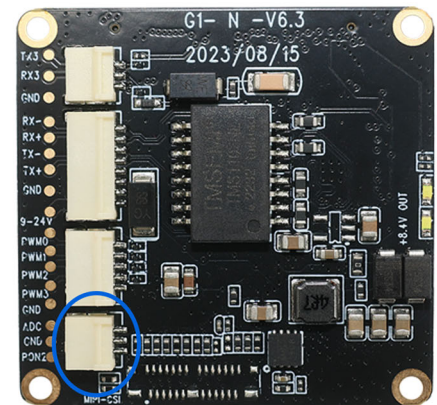
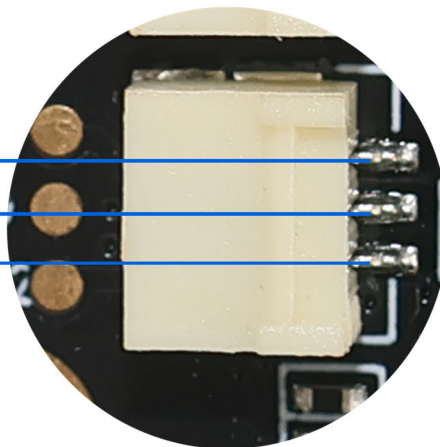

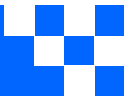

KLT-G1NK V6.3 Network Expansion Board

Requirements for using the Ethernet Port of the camera

1. The camera can be powered on automatically using 9V-24V power supply; the master board supports three-way simultaneous use, namely Ethernet board power supply, motherboard battery power supply, and Type-C USB power supply. It can also be used with a single power supply.

Special note:

The three-axis gimbal does not support 5V USB power supply alone. The battery power supply can support up to 12V; but this does not include the gimbal version, the stable power supply voltage of the battery for gimbal version is 8V.

2. The Ethernet function and the Type-C USB connection to the computer can be used at the same time. When using the USB flash drive or PCCAM mode, you need to connect the Type-C to the computer when the camera is turned off, and the camera will automatically turn on and enter the USB flash drive or PCCAM mode

3. The Ethernet Port of the camera will automatically turn on the Ethernet when it is turned on. It does not support local switching mode. If you need to control the camera to take pictures or set parameters, you can connect the Ethernet port to the network and control the camera in the APP; or input commands through the serial port (UART3) to control the camera.

Solution 1:

Connect the router through the network cable by the network plug and power supply interface. After turning on the device, the network indicator on the Ethernet board is always on, indicating that the device has been connected to the router network. (Network communication is successful, RTSP output is successful, one of the network port indicator lights is always on, and one of the white lights flashes quickly). Connect the mobile phone to the same network as the camera, enter the APP to control the device to record, take pictures, playback, set parameters, etc.

Connect the computer to the router network, open the PotPlayer player installed on the computer, click the upper left corner of the mouse to open the main menu drop down list, move the mouse to open and then move to the list on the right, left-click "Open Link", enter the address `rtsp://192.168.1.64:554/H264?W=1280&H=720&BR=2000000&FPS=30`, and select OK to display the current camera screen.

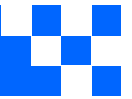

KLT-G1NK V6.3 Network Expansion Board

Solution 2:

Use the network cable defined by the network port and power supply interface, connect one end of the RJ45 plug directly to the computer, and set the local IP address; Note: You need to set a network IP other than 192.168.1.64, that is, the last digit is not 64. After the setting is successful, call cmd and enter the command ping 192.168.1.64 to check whether it is communicating.

Tip: After using the operation process of Solution 1, if you still cannot connect to the network, it may be that the gateway of the router is not 192.168.1.xx; at this time, you need to enter the router and change the gateway IP address to 192.168.1.xx (xx represents a number).

网口板连接主板扩展板接口

Net connect to main board

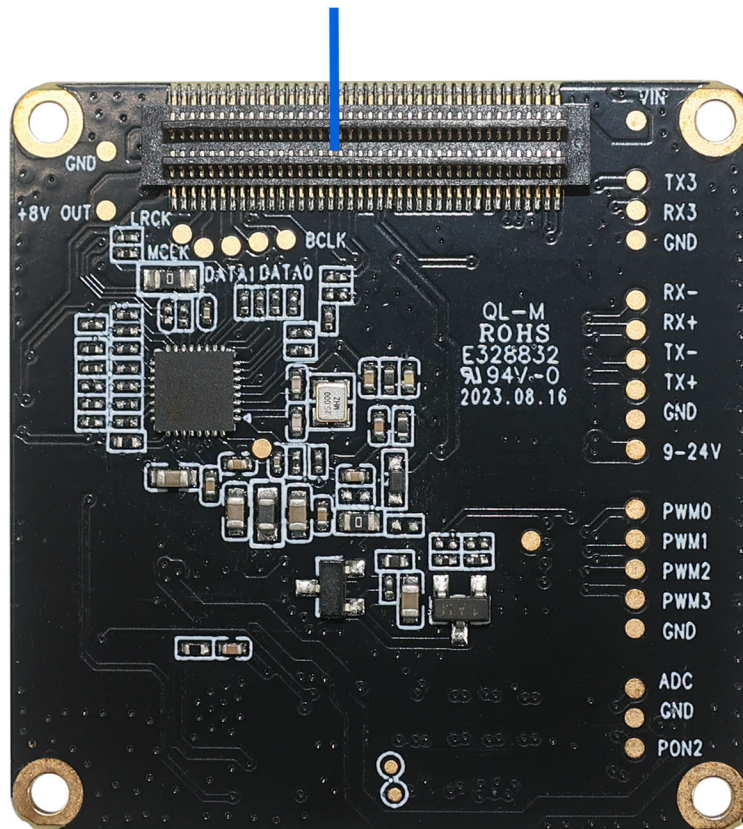

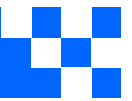

KLT-CMFL6007-IMX577 V1.0

112.3MP Sony IMX577 Fixed Focus Camera Module

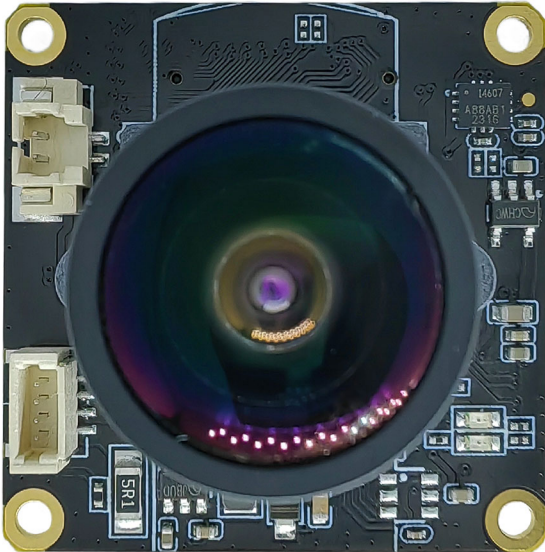

Front View

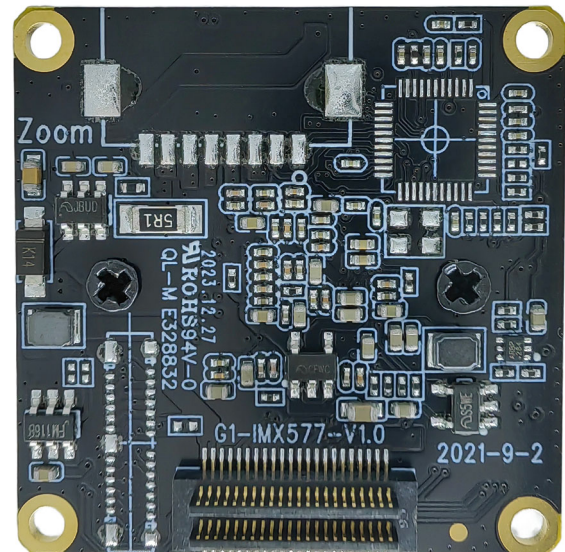

Back View

Overview

The KLT-CMFL6007-IMX577 V1.0 camera module uses the Sony IMX577 high-quality CMOS image sensor, which has a diagonal of 7.857mm (1/2.3 type) CMOS image sensor, a pixel size of 1.55 μ m, a color square pixel display, an effective pixel of 12 megapixels, and a high-definition image. When used with the master board, it can support 12MP high-definition photos, and can support up to 4K@60FPS (differential), 4K@30FPS video shooting.

Used with the master board, the coaxial cable is used to connect the main board or by directly plug in. The board frame size is 32x32mm, and the size from the top of the module lens to the PCB board surface is 23mm.

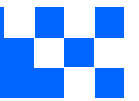

KLT-CMFL6007-IMX577 V1.0
112.3MP Sony IMX577 Fixed Focus Camera Module

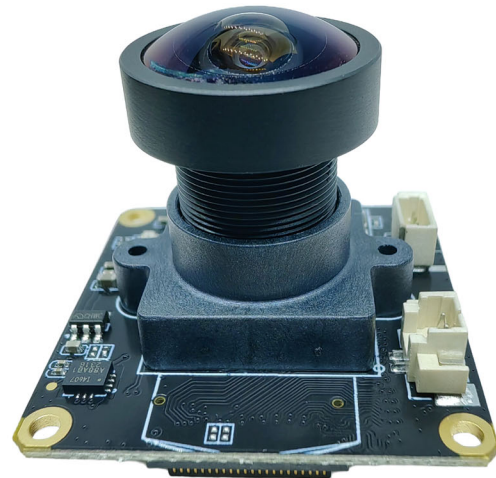



KLT-CMFL6007-IMX577 V1.0

112.3MP Sony IMX577 Fixed Focus Camera Module

Specifications

Model No.	KLT-CMFL6007-IMX577 V1.0
Image Sensor	IMX577
Image Sensor Type	CMOS
Effective Pixels	12.3 Megapixels
Sensor Size	1/2.3"
Pixel Size	1.55 um x 1.55 um
Video Frame Rate	4K@24/25/30/FPS, 4K@48/50/60FPS (Differential) 2.7K@24/25/30/48/50/60FPS 1080P@24/25/30/48/50/60/120FPS 720P@24/25/30/48/50/60/120/240FPS
Video Slow Motion	OFF, 4K2X, 1080P4X, 720P8X
Photo Resolution (with Master Board)	20MP (5200x3900) (Differential) 13MP (4160x3120) (Differential) 12MP (4000x3000) 10MP (3648x2736) 8MP (3264x2448) 5MP (2592x1944) 3MP (2048x1536) 2MP (1920x1080)
Operating Temperature	-10°C to +60°C
Storage Temperature	-20°C to +80°C
Humidity	20% to 80%
PCB Dimensions	32 x 32 mm
Module Size	32 x 32 x 24 mm
PCB Screw Hole Spacing	28 x 28 mm
PCB Screw Hole Diameter	2 mm
Lens Mount Screw Diameter	1.6 mm

KLT-CMFL6007-IMX577 V1.0

112.3MP Sony IMX577 Fixed Focus Camera Module

Lens Specifications

Lens Model No.	HX6007
EFL (Focal Length)	2.70 mm
BFL	5.03 mm
TTL (Total Length)	22.90 mm
IR Coating	T=50%@650nm +/- 10nm
F. No.	2.8
Lens Barrel Thread	M12 x P0.5
Lens Construction	8G + 1E
Diagonal View Angle (DFOV)	170° (DFOV)
Horizontal View Angle (HFOV)	130° (HFOV)
Vertical View Angle (VFOV)	96.7° (VFOV)
Distortion	<1.0%
Relative Illumination	>72%
Lens Operating Temperature	-10°C to +60°C
Lens Storage Temperature	-20°C to +80°C

Lens Drawing

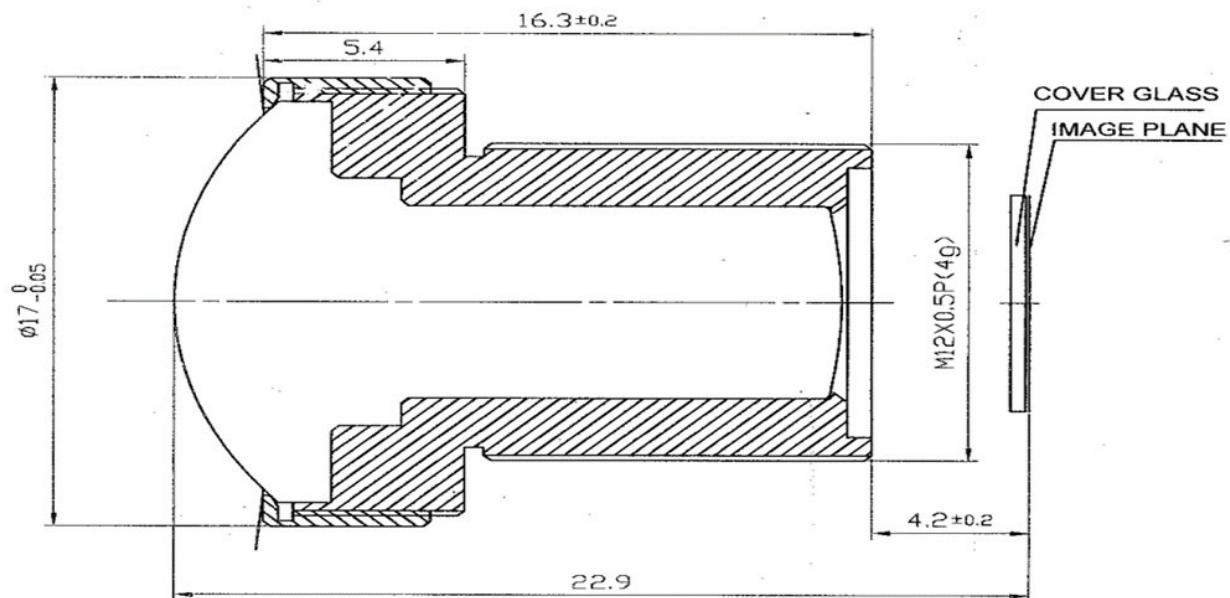

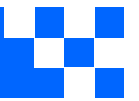
**KLT-CMFL6007-IMX577 V1.0****112.3MP Sony IMX577 Fixed Focus Camera Module**

濾光片切换器接口
IR-CUT INTERFACE

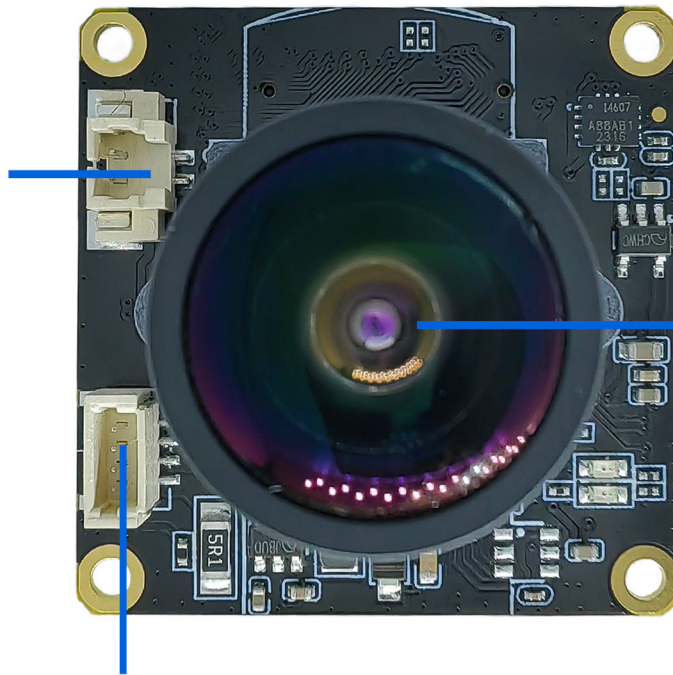

G1-IMX577 HX6007
V1.0镜头模组

两组LED补光灯接口

LEDS * 2 INTERFACE

KLT-CMFL6007-IMX577 V1.0
112.3MP Sony IMX577 Fixed Focus Camera Module

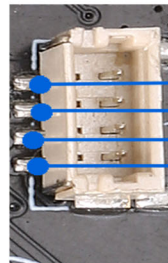
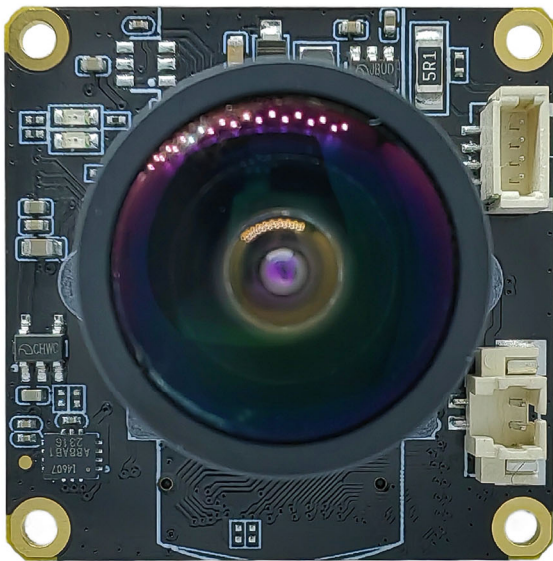

LED B -
LED B +
LED A -
LED A +

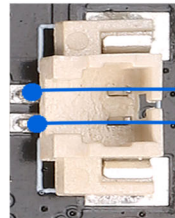

IR-CUT -
IR-CUT +

Special Note:

The two sets of fill light interfaces support the expansion of infrared light and white light boards to provide fill light for the device. If you need the fill light function, you need to add the KLT-LEDP V2.0 White and Infrared Light LED Plate.

When used with the IR cut filter lens, the infrared light can be switched automatically or manually, making videos and photos clearer at night.



KLT-CMFL6007-IMX577 V1.0
112.3MP Sony IMX577 Fixed Focus Camera Module

通过板对板连接器连接G1主板 支持Sensor、IR-CUT、LED等

Connect Sensor, IR-CUT, LED etc.

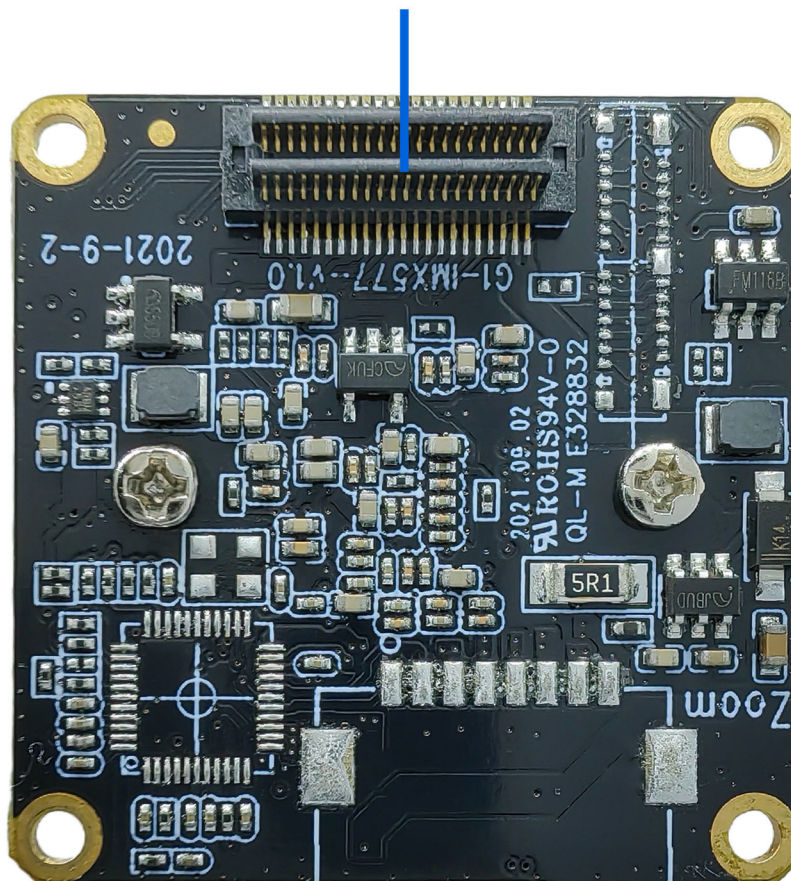

[Product Information]

IMX577-AACK

Ver.1.0

Diagonal 7.857 mm (Type 1/2.3) 12.3 Mega-Pixel CMOS Image Sensor with Square Pixel for Color Cameras

Description

The IMX577-AACK is a diagonal 7.857 mm (Type 1/2.3) 12.3 Mega-pixel CMOS active pixel type stacked image sensor with a square pixel array. It adopts Sony's Stacked CMOS Image Sensor technology to achieve high speed image capturing by column parallel A/D converter circuits and high sensitivity and low noise image (comparing with conventional CMOS image sensor) through the backside illuminated imaging pixel structure. R, G, and B pigment primary color mosaic filter is employed. It equips an electronic shutter with variable integration time. It operates with three power supply voltages: analog 2.8 V, digital 1.05 V and 1.8 V for input/output interface and achieves low power consumption.

In addition, this product is designed for use in consumer use camcorder. When using this for another application, Sony Semiconductor Solutions Corporation does not guarantee the quality and reliability of product. Therefore, don't use this for applications other than consumer use camcorder.

In addition, individual specification change cannot be supported because this is a standard product.

Consult your Sony Semiconductor Solutions Corporation sales representative if you have any questions.

Features

- ◆ Back-illuminated and stacked CMOS image sensor
- ◆ Digital Overlap High Dynamic Range (DOL-HDR) mode with raw data output.
- ◆ High signal to noise ratio (SNR).
- ◆ Full resolution @60 frame/s (Normal), 4K2K @60 frame/s (Normal), 1080p @240 frame/s
Full resolution @40 frame/s (12 bit Normal), Full resolution @30 frame/s (DOL-HDR, 2 frame)
- ◆ Output video format of RAW12/10/8, COMP8.
- ◆ Power Save Mode with MIPI ULPS operation
- ◆ Pixel binning readout and V sub-sampling function.
- ◆ Independent flipping and mirroring.
- ◆ Input clock frequency 6 to 27 MHz
- ◆ CSI-2 serial data output (MIPI 2lane/4lane, Max. 2.1 Gbps/lane, D-PHY spec. ver. 1.2 compliant)
- ◆ 2-wire serial communication.
- ◆ Two PLLs for independent clock generation for pixel control and data output interface.
- ◆ Defect Pixel Correction (DPC)
- ◆ Ambient Light Sensor (ALS)
- ◆ Fast mode transition. (on the fly)
- ◆ Dual sensor synchronization operation (Multi camera compatible)
- ◆ 7 k bit of OTP ROM for users.
- ◆ Built-in temperature sensor
- ◆ 10-bit/12-bit A/D conversion on chip
- ◆ Horizontal Low Power Analog Cropping
- ◆ Window Scanning mode
- ◆ 92-pin high-precision ceramic package

Sony reserves the right to change products and specifications without prior notice.

Sony logo is a registered trademark of Sony Corporation.

Device Structure

- ◆ CMOS image sensor
- ◆ Image size Diagonal 7.857 mm (Type 1/2.3)
- ◆ Total number of pixels 4072 (H) × 3176 (V) approx. 12.93 M pixels
- ◆ Number of effective pixels 4072 (H) × 3064 (V) approx. 12.47 M pixels
- ◆ Number of active pixels 4056 (H) × 3040 (V) approx. 12.33 M pixels
- ◆ Chip size 7.564 mm (H) × 5.476 mm (V)
- ◆ Unit cell size 1.55 μm (H) × 1.55 μm (V)
- ◆ Package 92 pin LGA

Image Sensor Characteristics

(Tj = 60 °C)

Item		Value	Remarks
Sensitivity (F2.8)	Min.	250 LSB	1/120 s integration
Saturation signal	Min.	1023 LSB	

Basic Drive Mode

Drive mode	Number of active pixels	Maximum frame rate [frame/s]	Output interface	ADC [bit]
Full (4:3) (Normal)	4056 (H) × 3040 (V) approx. 12.33 M pixels	60	CSI-2	10
		43	CSI-2	12
Full (4:3) (DOL-HDR)	4056 (H) × 3040 (V) approx. 12.33 M pixels	DOL 2 frame : 30 DOL 3 frame : 15	CSI-2	10
Full (16:9) 4K2K (Normal)	4056 (H) × 2288 (V) approx. 9.28 M pixels	79	CSI-2	10
Full (16:9) 4K2K (DOL-HDR)	4056 (H) × 2288 (V) approx. 9.28 M pixels	DOL 2 frame : 39 DOL 3 frame : 19	CSI-2	10
Full (4:3) Binning (Normal)	2028 (H) × 1520 (V) approx. 3.08 M pixels	178	CSI-2	10
Full (16:9) Binning 1080P (Normal)	2028 (H) × 1112 (V) approx. 2.26 M pixels	241	CSI-2	10
Full (16:9) Binning 720P (Normal)	1352 (H) × 740 (V) approx. 1.00 M pixels	241	CSI-2	10
Full (16:9) Scaling 1080P (Normal)	2028 (H) × 1144 (V) approx. 2.32 M pixels	79	CSI-2	10
Full (16:9) Scaling 720P (Normal)	1352 (H) × 762 (V) approx. 1.03 M pixels	79	CSI-2	10



your BEST camera module partner

Cameras Applications



Automotive Driver Pilot



Live Streaming



Video Conference



Eye Tracker Biometric Detection



Machine Vision



Agricultural Monitor



Night Vision Security



Drone and Sports Eagle Eyes



Interactive Pet Camera

www.KaiLapTech.com sales@KaiLapTech.com Tel: (852) 6908 1256 Fax: (852) 3017 6778

All rights reserved @ Kai Lap Technologies Group Ltd. Specifications subject to change without notice.



your **BEST** camera module partner

Cameras Applications



IMAGING DEVICES





Camera Module Pinout Definition Reference Chart

OmniVision	Sony	Samsung	On-Semi	Aptina	Himax	GalaxyCore	PixArt	SmartSens	Sensors
Pin Signal									
Description									
DGND	GND								
AGND									
PCLK	DCK								
XCLR	PWDN	XSHUTDOWN	STANDBY						
MCLK	XVCLK	XCLK	INCK						
RESET	RST								
NC	NULL								
SDA	SIO_D	SIOD							
SCL	SIO_C	SIOC							
VSYNC	XVS	FSYNC							
HREF	XHS								
DOVDD									
AFVDD									
AVDD									
DVDD									
STROBE	FSTROBE								
FSIN									
SID									
ILPWM									
FREX									
GPIO									
SLASEL									
AFEN									
MIPI Interface									
MDN0	DN0	MD0N	DATA_N	DMO1N					
MDP0	DP0	MD0P	DATA_P	DMO1P					
MDN1	DN1	MD1N	DATA2_N	DMO2N					
MDP1	DP1	MD1P	DATA2_P	DMO2P					
MDN2	DN2	MD2N	DATA3_N	DMO3N					
MDP2	DP2	MD2P	DATA3_P	DMO3P					
MDN3	DN3	MD3N	DATA4_N	DMO4N					
MDP3	DP3	MD3P	DATA4_P	DMO4P					
MCN	CLKN	CLK_N	DCKN						
MCP	CLKP	MCP	CLK_P	DCKN					
DVP Parallel Interface									
D0	DO0	Y0							
D1	DO1	Y1							
D2	DO2	Y2							
D3	DO3	Y3							
D4	DO4	Y4							
D5	DO5	Y5							
D6	DO6	Y6							
D7	DO7	Y7							
D8	DO8	Y8							
D9	DO9	Y9							
D10	DO10	Y10							
D11	DO11	Y11							



Camera Reliability Test

Reliability Inspection Item		Testing Method	Acceptance Criteria	
Category	Item			
Environmental	Storage Temperature	High 60°C 96 Hours	Temperature Chamber	No Abnormal Situation
		Low -20°C 96 Hours	Temperature Chamber	No Abnormal Situation
	Operation Temperature	High 60°C 24 Hours	Temperature Chamber	No Abnormal Situation
		Low -20°C 24 Hours	Temperature Chamber	No Abnormal Situation
	Humidity	60°C 80% 24 Hours	Temperature Chamber	No Abnormal Situation
	Thermal Shock	High 60°C 0.5 Hours Low -20°C 0.5 Hours Cycling in 24 Hours	Temperature Chamber	No Abnormal Situation
Physical	Drop Test (Free Falling)	Without Package 60cm	10 Times on Wood Floor	Electrically Functional
		With Package 60cm	10 Times on Wood Floor	Electrically Functional
	Vibration Test	50Hz X-Axis 2mm 30min	Vibration Table	Electrically Functional
		50Hz Y-Axis 2mm 30min	Vibration Table	Electrically Functional
		50Hz Z-Axis 2mm 30min	Vibration Table	Electrically Functional
	Cable Tensile Strength Test	Loading Weight 4 kg 60 Seconds Cycling in 24 Hours	Tensile Testing Machine	Electrically Functional
Electrical	ESD Test	Contact Discharge 2 KV	ESD Testing Machine	Electrically Functional
		Air Discharge 4 KV	ESD Testing Machine	Electrically Functional
	Aging Test	On/Off 30 Seconds Cycling in 24 Hours	Power Switch	Electrically Functional
	USB Connector	On/Off 250 Times	Plug and Unplug	Electrically Functional





Inspection Item		Inspection Method	Standard of Inspection		
Category	Item				
Appearance	FPC/ PCB	Color	The Naked Eye	Major Difference is Not Allowed.	
		Be Torn/Chopped	The Naked Eye	Copper Crack Exposure is Not Allowed.	
		Marking	The Naked Eye	Clear, Recognizable (Within 30cm Distance)	
	Holder	Scratches	The Naked Eye	The Inside Crack Exposure is Not Allowed	
		Gap	The Naked Eye	Meet the Height Standard	
		Screw	The Naked Eye	Make Sure Screws Are Presented (If Any)	
		Damage	The Naked Eye	The Inside Crack Exposure is Not Allowed	
	Lens	Scratch	The Naked Eye	No Effect On Resolution Standard	
		Contamination	The Naked Eye	No Effect On Resolution Standard	
		Oil Film	The Naked Eye	No Effect On Resolution Standard	
		Cover Tape	The Naked Eye	No Issue On Appearance.	
	Function	Image	No Communication	Test Board	Not Allowed
			Bright Pixel	Black Board	Not Allowed In the Image Center
Dark Pixel			White board	Not Allowed In the Image Center	
Blurry			The Naked Eye	Not Allowed	
No Image			The Naked Eye	Not Allowed	
Vertical Line			The Naked Eye	Not Allowed	
Horizontal Line			The Naked Eye	Not Allowed	
Light Leakage			The Naked Eye	Not Allowed	
Blinking Image			The Naked Eye	Not Allowed	
Bruise			Inspection Jig	Not Allowed	
Resolution			Chart	Follows Outgoing Inspection Chart Standard	
Color			The Naked Eye	No Issue	
Noise			The Naked Eye	Not Allowed	
Corner Dark			The Naked Eye	Less Than 100px By 100px	
Color Resolution			The Naked Eye	No Issue	
Dimension	Height	The Naked Eye	Follows Approval Data Sheet		
	Width	The Naked Eye	Follows Approval Data Sheet		
	Length	The Naked Eye	Follows Approval Data Sheet		
	Overall	The Naked Eye	Follows Approval Data Sheet		



KLT Package Solutions

KLT Camera Module



Complete with Lens Protection Film



Tray with Grid and Space



Place Cameras on the Tray

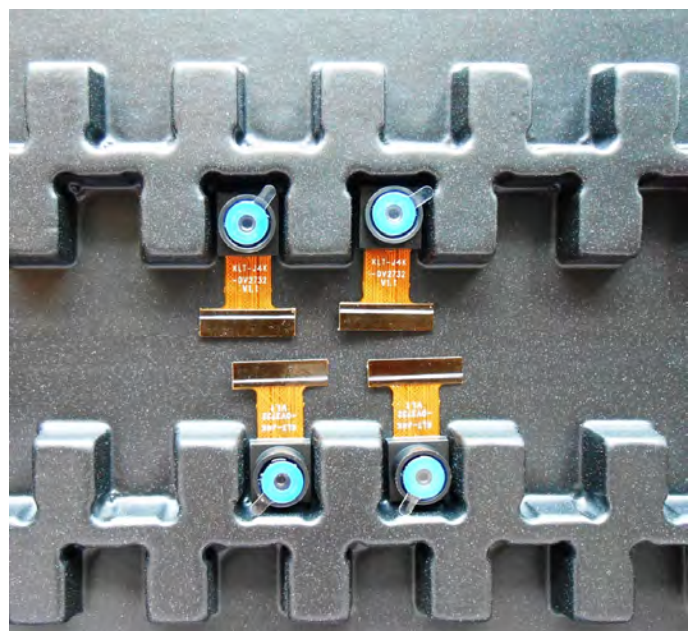



Camera Modules Package Solution

Full Tray of Cameras



Cover Tray with Lid



Put Tray into Anti-Static Bag



Vacuum the Anti-Static Bag

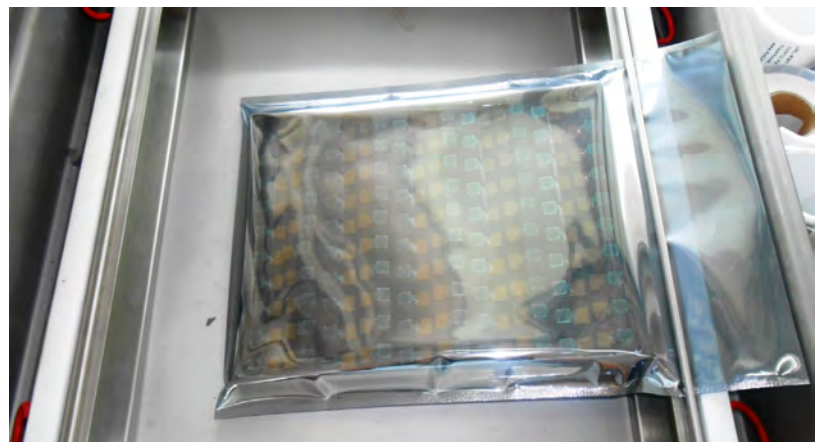



Camera Modules Package Solution

Sealed Vacuum Bag with Labels

1. Model and Description 2. Quantity 3. Shipping Date 4. Caution





Large Order Package Solution

Place Foam Sheets Between Trays



Foam Sheets are Slightly Larger than Trays



Place Foam Sheets and Trays into Box



Foam Sheets are Tightly Fitting Box





Small Order Package Solution

Place Foam Sheets and Trays into Small Box



Foam Sheets are Nicely Fitting the Small Box



Package in Small Box for Shipment



Place Small Boxes into Larger Box





CMOS CAMERA MODULES



your BEST camera module partner

Carbon Box Package Solution

Seal the Carbon Box

Final Package Labelled Box



Carbon Box Ready for Shipment

1. Delivery Address and Phone No.
2. Box No. and Ship Date
3. Fragile Caution



www.KaiLapTech.com sales@KaiLapTech.com Tel: (852) 6908 1256 Fax: (852) 3017 6778

All rights reserved @ Kai Lap Technologies Group Ltd. Specifications subject to change without notice.



Sample Order Package Solution

Place Sample into Small Anti-Static Bag



Place Connectors into Small Ant-Static Bag



Sample Labels on the Small Bag

1. Camera Module or Connector Model
2. Shipping Date and Quantity
3. Caution





Connectors Large Order Package Solution

Connectors in a Wheel



Label Connectors in the Wheel



The Wheel is Perfectly Fitting the Box



Connectors Box Ready for Shipment





your BEST camera module partner

Company Kai Lap Technologies (KLT)

Kai Lap Technologies Group Limited. (KLT) was established in 2009, a next-generation technology driven manufacturer specialized in research, design, and produce of audio and video products. KLT is occupying 20,000 square feet automated plants with 100 employees of annual throughput 30,000,000 units cameras.

KLT provides OEM, ODM design, contract manufacturing, and builds the camera products. You may provide the requirements to us, even with a hand draft, our sales and engineering work together to meet your needs. We consider ourselves your last-term partner in developing practical and innovative solutions.

Our team covers everything from initial concept development to mass produced product. KLT specializes in customized camera design, raw material, electronic engineering, firmware/software development, product testing, and packing design. Our experienced strategic supply systems offer a robust and dependable manufacturing capacity for orders of various sizes.

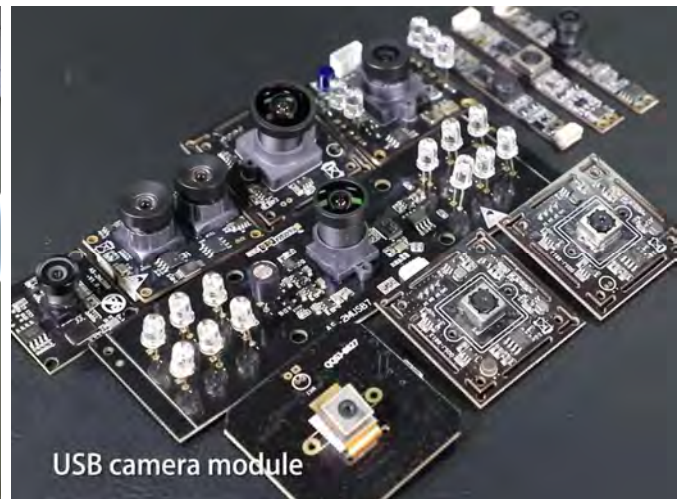

Limited Warranty

KLT provides the following limited warranty if you purchased the Product(s) directly from KLT company or from KLT's website, www.KaiLapTech.com. Product(s) purchased from other sellers or sources are not covered by this Limited Warranty. KLT guarantees that the Product(s) will be free from defects in materials and workmanship under normal use for a period of one (1) year from the date you receive the product ("Warranty Period").

For all Product(s) that contain or develop material defects in materials or workmanship during the Warranty Period, KLT will, at its sole option, either: (i) repair the Product(s); (ii) replace the Product(s) with a new or refurbished Product(s) (replacement Product(s) being of identical model or functional equivalent); or (iii) provide you a refund of the price you paid for the Product(s).

This Limited Warranty of KLT is solely limited to repair and/or replacement on the terms set forth above. KLT is not reliable or responsible for any subsequent events.





CMOS CAMERA MODULES



your BEST camera module partner

KLT Strength

Powerful Factory



Professional Service



Promised Delivery



www.KaiLapTech.com sales@KaiLapTech.com Tel: (852) 6908 1256 Fax: (852) 3017 6778

All rights reserved @ Kai Lap Technologies Group Ltd. Specifications subject to change without notice.